

## ZŁĄCZKI ZACISKANE CALIDO z miedzi i stopów miedzi



### Przeznaczenie:

Złączki zaciskane Calido z miedzi i stopów miedzi przeznaczone są do stosowania w instalacjach wodociągowych (w tym także instalacjach wody przeznaczonej do spożycia przez ludzi), grzewczych, klimatyzacyjnych oraz instalacjach sprężonego powietrza.

Złączki miedziane należy dobierać uwzględniając właściwości korozyjne wody oraz materiały, z których wykonano inne elementy instalacji wodociągowej w celu uniknięcia przyspieszonej korozji i awarii instalacji. Każdą instalację przed jej oddaniem do użytkowania należy poddać płukaniu i próbie szczelności.

### System detekcji niezaciśniętych połączeń:

Złączki zaciskane Calido wyposażone są w system detekcji niezaciśniętych połączeń. Dzięki odpowiednio ukształtowanym uszczelkom typu o-ring każde niezaciśnięte połączenie złączki z rurą będzie nieszczelne i nastąpi wyciek w zakresie ciśnienia próbnego  $\leq 6$  bar. Wyciek na niezaciśniętym połączeniu będzie skutkował spadkiem ciśnienia widocznym na manometrze podczas wykonywanej próby szczelności na wykonanej instalacji.

### Dane techniczne:

	Woda	Sprężone powietrze
Ciśnienie maksymalne	16 bar	10 bar
Tmin	-10°C	5°C
Tmax	110°C	35°C

Materiał złączki: **CW024A / CW511L**  
Uszczelnienie o-ring: **EPDM**

### Certyfikaty:

Znakowanie



Produkt z Atestem **NIZP-PZH**. Krajowa deklaracja właściwości użytkowych **4/calido/2023**

Produkt zgodny z normą **PN-EN 1254-7:2021-10**.

## Wymiary:

### ZASŁEPKA

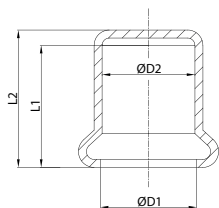

### MUFA ZACISK / ZACISK

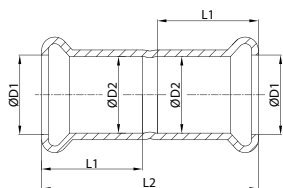

### MUFA PRZESUWNA ZACISK / ZACISK

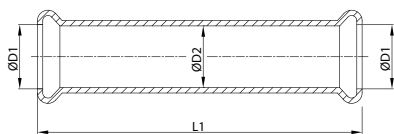

### NYPEL REDUKCYJNY ZACISK / Cu

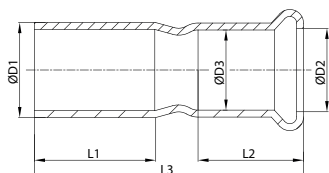

### MUFA REDUKCYJNA ZACISK / ZACISK

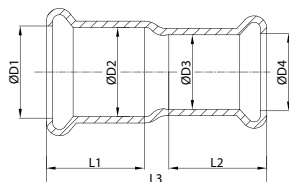

Indeks	Rozmiar	ØD1 mm	ØD2 mm	L1 mm	L2 mm
CA/ZM-300-15	15	15,8	15,2	20	22
CA/ZM-300-18	18	18,8	18,2	20	23
CA/ZM-300-22	22	22,8	22,2	21	24,5
CA/ZM-300-28	28	28,8	28,2	23	26,5

Indeks	Rozmiar	ØD1 mm	ØD2 mm	L1 mm	L2 mm
CA/ZM-270-15	15x15	15,8	15,2	20	43
CA/ZM-270-18	18x18	18,8	18,2	20	42
CA/ZM-270-22	22x22	22,8	22,2	21	44
CA/ZM-270-28	28x28	28,8	28,2	23	48
CA/ZM-270-35	35x35	35,9	35,3	26	55

Indeks	Rozmiar	ØD1 mm	ØD2 mm	L1 mm
CA/ZM-271-15	15x15	15,8	15,2	80
CA/ZM-271-18	18x18	18,8	18,2	80
CA/ZM-271-22	22x22	22,8	22,2	80
CA/ZM-271-28	28x28	28,8	28,2	90
CA/ZM-271-35	35x35	25,9	35,3	102

Indeks	Rozmiar	ØD1 mm	ØD2 mm	ØD3 mm	L1 mm	L2 mm	L3 mm
CA/ZM-245-1815	18x15	18	15,8	15,2	23	20	51
CA/ZM-245-2215	22x15	22	15,8	15,2	24	20	50
CA/ZM-245-2218	22x18	22	18,8	18,2	24	20	50
CA/ZM-245-2815	28x15	28	15,8	15,2	27	20	55
CA/ZM-245-2818	28x18	28	18,8	18,2	27	20	54
CA/ZM-245-2822	28x22	28	22,8	22,2	27	21	53
CA/ZM-245-3522	35x22	35	22,8	22,2	30	21	60
CA/ZM-245-3528	35x28	35	28,8	28,2	30	23	59

Indeks	Rozmiar	ØD1 mm	ØD2 mm	ØD3 mm	ØD4 mm	L1 mm	L2 mm	L3 mm
CA/ZM-240-1815	18x15	18,8	18,2	15,2	15,8	20	20	45
CA/ZM-240-2215	22x15	22,8	22,2	15,2	15,8	21	20	46,5
CA/ZM-240-2218	22x18	22,8	22,2	18,2	18,8	21	20	46,5
CA/ZM-240-2815	28x15	28,8	28,2	15,2	15,8	23	20	53
CA/ZM-240-2818	28x18	28,8	28,2	18,2	18,8	23	20	51,5
CA/ZM-240-2822	28x22	28,8	28,2	22,2	22,8	23	21	50,5
CA/ZM-240-3515	35x15	35,9	35,3	15,2	15,8	26	20	60,5
CA/ZM-240-3522	35x22	35,9	35,3	22,2	22,8	26	21	57
CA/ZM-240-3528	35x28	35,9	35,3	28,2	28,8	26	23	56

## Wymiary:

### TRÓJNIK REDUKCYJNY ZACISK

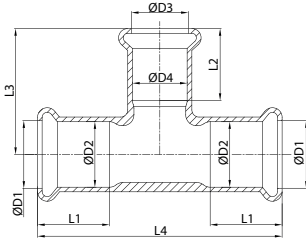

Indeks	Rozmiar	ØD1 mm	ØD2 mm	ØD3 mm	ØD4 mm	L1 mm	L2 mm	L3 mm	L4 mm
CA/ZM-130R-181518	18x15x18	18,8	18,2	15,8	15,2	20	20	35	68
CA/ZM-130R-221522	22x15x22	22,8	22,2	15,8	15,2	21	20	38	74
CA/ZM-130R-221822	22x18x22	22,8	22,2	18,8	18,2	21	20	38	74
CA/ZM-130R-281528	28x15x28	28,8	28,2	15,8	15,2	23	20	40,5	84
CA/ZM-130R-281828	28x18x28	28,8	28,2	18,8	18,2	23	20	40,5	84
CA/ZM-130R-282222	28x22x22	28,8	28,2	22,8	22,2	23	21	41	84,5
CA/ZM-130R-282228	28x22x28	28,8	28,2	22,8	22,2	23	21	41	84
CA/ZM-130R-351535	35x15x35	35,9	35,3	15,8	15,2	26	20	44	90
CA/ZM-130R-352235	35x22x35	35,9	35,3	22,8	22,2	26	21	45	90
CA/ZM-130R-352835	35x28x35	35,9	35,3	28,8	28,2	26	23	44	100

### TRÓJNIK ZACISK

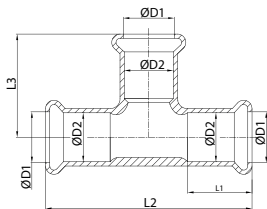

Indeks	Rozmiar	ØD1 mm	ØD2 mm	L1 mm	L2 mm	L3 mm
CA/ZM-130-15	15	15,8	15,2	20	64	32
CA/ZM-130-18	18	18,8	18,2	20	68	34
CA/ZM-130-22	22	22,8	22,2	21	74	37
CA/ZM-130-28	28	28,8	28,2	23	84	42
CA/ZM-130-35	35	35,9	35,3	26	100	50

### ŁUK NYPLOWY 45° Cu

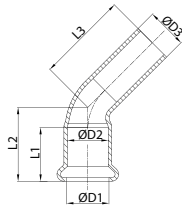

Indeks	Rozmiar	ØD1 mm	ØD2 mm	ØD3 mm	L1 mm	L2 mm	L3 mm
CA/ZM-40-15	15	15,8	15,2	15	20	27,5	34
CA/ZM-40-18	18	18,8	18,2	18	20	29	37
CA/ZM-40-22	22	22,8	22,2	22	21	32	42
CA/ZM-40-28	28	28,8	28,2	28	23	37	45,4
CA/ZM-40-35	35	35,9	35,3	35	26	43,5	58

### ŁUK NYPLOWY 90° Cu

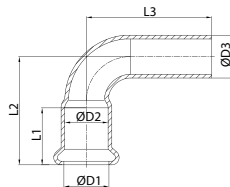

Indeks	Rozmiar	ØD1 mm	ØD2 mm	ØD3 mm	L1 mm	L2 mm	L3 mm
CA/ZM-1-15	15	15,8	15,2	15	20	38	44
CA/ZM-1-18	18	18,8	18,2	18	20	41,6	50
CA/ZM-1-22	22	22,8	22,2	22	21	47,4	58
CA/ZM-1-28	28	28,8	28,2	28	23	56,6	65
CA/ZM-1-35	35	35,9	35,3	35	26	68	82

### ŁUK 45° ZACISK / ZACISK

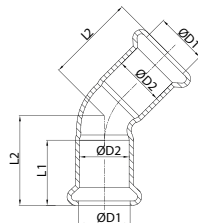

Indeks	Rozmiar	ØD1 mm	ØD2 mm	L1 mm	L2 mm
CA/ZM-41-15	15	15,8	15,2	20	27,5
CA/ZM-41-18	18	18,8	18,2	20	29
CA/ZM-41-22	22	22,8	22,2	21	32
CA/ZM-41-28	28	28,8	28,2	23	37
CA/ZM-41-35	35	35,9	35,3	26	43,5

### ŁUK 90° ZACISK / ZACISK

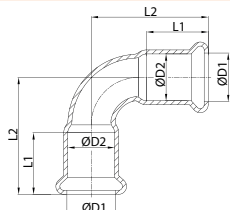

Indeks	Rozmiar	ØD1 mm	ØD2 mm	L1 mm	L2 mm
CA/ZM-2-15	15	15,8	15,2	20	38
CA/ZM-2-18	18	18,8	18,2	20	41,6
CA/ZM-2-22	22	22,8	22,2	21	47,4
CA/ZM-2-28	28	28,8	28,2	23	56,6
CA/ZM-2-35	35	35,9	35,3	26	68

## Wymiary:

### ODSADZKA ZACISK / ZACISK

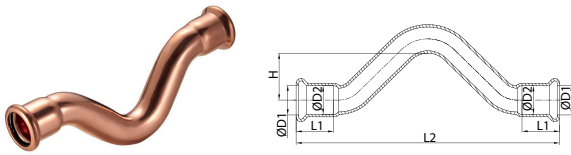

Indeks	Rozmiar	ØD1 mm	ØD2 mm	L1 mm	L2 mm	H mm
CA/ZM-85-15	15	15,8	15,2	20	140	32,5
CA/ZM-85-18	18	18,8	18,2	20	152	34
CA/ZM-85-22	22	22,8	22,2	21	172	36

### ODSADZKA NYPLOWA ZACISK / Cu

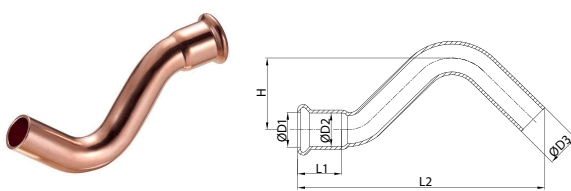

Indeks	Rozmiar	ØD1 mm	ØD2 mm	ØD3 mm	L1 mm	L2 mm	H mm
CA/ZM-86-15	15	15,8	15,2	15	20	112	32,5
CA/ZM-86-18	18	18,8	18,2	18	20	117	34
CA/ZM-86-22	22	22,8	22,2	22	21	133	36

### NYPEL PRZEJŚCIOWY ZACISK / GZ

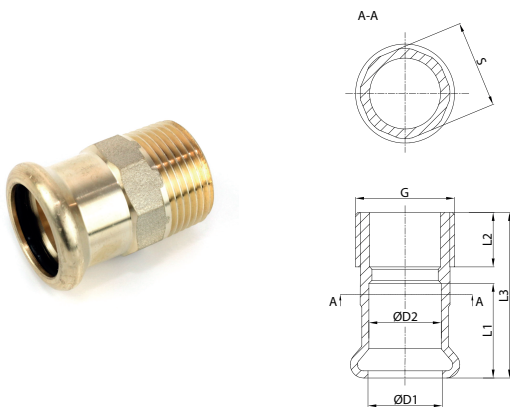

Indeks	Rozmiar	ØD1 mm	ØD2 mm	L1 mm	L2 mm	L3 mm	S mm	G mm
CA/ZM-243G-15X1/2	15X1/2"GZ	15,7	15,3	20	11,5	35	19	1/2"
CA/ZM-243G-15X3/4	15X3/4"GZ	15,7	15,3	20	15	41	19	3/4"
CA/ZM-243G-18X1/2	18X1/2"GZ	18,7	18,3	20	11,5	36	22	1/2"
CA/ZM-243G-18X3/4	18X3/4"GZ	18,7	18,3	20	13	40	22	3/4"
CA/ZM-243G-22X1/2	22X1/2"GZ	22,7	22,3	19	11,5	41	22	1/2"
CA/ZM-243G-22X3/4	22X3/4"GZ	22,7	22,3	21	13	42	26,5	3/4"
CA/ZM-243G-22X1	22X1"GZ	22,7	22,3	21	16,5	46,5	26,5	1"
CA/ZM-243G-28X3/4	28X3/4"GZ	28,7	28,3	23	13	49	28	3/4"
CA/ZM-243G-28X1	28X1"GZ	28,7	28,3	23	14,5	48	34	1"
CA/ZM-243G-35X1	35X1"GZ	35,7	35,3	26	14,5	56,6	34	1"
CA/ZM-243G-35X11/4	35X1 1/4"GZ	35,7	35,3	26	17	55	38,8	1 1/4"

### MUFA PRZEJŚCIOWA ZACISK / Cu

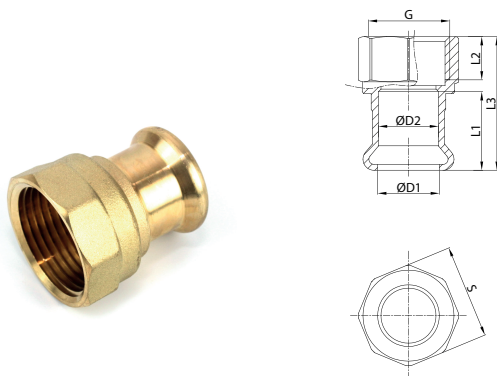

Indeks	Rozmiar	ØD1 mm	ØD2 mm	L1 mm	L2 mm	L3 mm	S mm	G mm
CA/ZM-270G-15X1/2	15X1/2"GW	15,7	15,3	20	11	34	24	1/2"
CA/ZM-270G-15X3/4	15X3/4"GW	15,7	15,3	20	13	39	30	3/4"
CA/ZM-270G-18X1/2	18X1/2"GW	18,7	18,3	20	11	34	24	1/2"
CA/ZM-270G-18X3/4	18X3/4"GW	18,7	18,3	20	12	38	30	3/4"
CA/ZM-270G-22X1/2	22X1/2"GW	22,7	22,3	20	11	35	24	1/2"
CA/ZM-270G-22X3/4	22X3/4"GW	22,7	22,3	21	13	42	30	3/4"
CA/ZM-270G-22X1	22X1"GW	22,7	22,3	21	17	43	37	1"
CA/ZM-270G-28X3/4	28X3/4"GW	28,7	28,3	23	13	40,5	32,5	3/4"
CA/ZM-270G-28X1	28X1"GW	28,7	28,3	23	16	46	37	1"
CA/ZM-270G-35X1	35X1"GW	35,7	35,3	26	14,5	44	37	1"
CA/ZM-270G-35X11/4	35X1 1/4"GW	35,7	35,3	26	17	49,3	46	1 1/4"

## Wymiary:

### PÓŁSRUBNEK ZACISK / GW

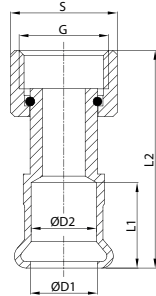

Indeks	Rozmiar	ØD1 mm	ØD2 mm	L1 mm	L2 mm	S mm	G
CA/ZM-359G-15X1/2	15x1/2"GW	15,7	15,3	20	42	26	1/2"
CA/ZM-359G-15X3/4	15x3/4"GW	15,7	15,3	20	31	30	3/4"
CA/ZM-359G-22X3/4	22x3/4"GW	22,7	22,3	21	44	30	3/4"
CA/ZM-359G-22X1	22x1"GW	22,7	22,3	21	34,5	38	1"
CA/ZM-359G-28X1 1/4	28x1 1/4"GW	28,7	28,3	25,5	40	46	1 1/4"
CA/ZM-359G-35X1 1/2	35x1 1/2"GW	35,7	35,3	26	42,2	52	1 1/2"

### TRÓJNIK ZACISK / GW

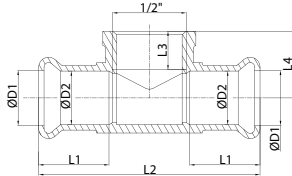

Indeks	Rozmiar	ØD1 mm	ØD2 mm	L1 mm	L2 mm	L3 mm	L4 mm
CA/ZM-130G-15X1/2X15	15x1/2"GWx15	15,7	15,3	20	63	11	19
CA/ZM-130G-18X1/2X18	18x1/2"GWx18	18,7	18,3	20	66	11	21
CA/ZM-130G-22X1/2X22	22x1/2"GWx22	22,7	22,3	21	70	11	22
CA/ZM-130G-28X1/2X28	28x1/2"GWx28	28,7	28,3	23	76	13	28
CA/ZM-130G-35X1/2X35	35x1/2"GWx35	35,7	35,3	26	83	12,5	30,5

### KOLANO ZACISK / GZ

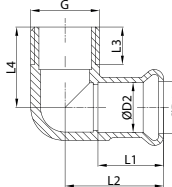

Indeks	Rozmiar	ØD1 mm	ØD2 mm	L1 mm	L2 mm	L3 mm	L4 mm	G
CA/ZM-92-15X1/2	15x1/2"GZ	15,7	15,3	20	30	11,4	24,5	1/2"
CA/ZM-92-22X3/4	22x3/4"GZ	22,7	22,3	21	37	13	30,5	3/4"
CA/ZM-92-28X1	28X1"GZ	28,7	28,3	23	42	15	36	1"

### KOLANO ZACISK / GW

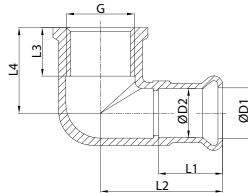

Indeks	Rozmiar	ØD1 mm	ØD2 mm	L1 mm	L2 mm	L3 mm	L4 mm	G
CA/ZM-90-15X1/2	15x1/2"GW	15,7	15,3	20	38	15	26,5	1/2"
CA/ZM-90-22X3/4	22X3/4"GW	22,7	22,3	21	42	12,2	24	3/4"
CA/ZM-90-28X1	28X1"GW	28,7	28,3	23	48	13,9	31	1"

### KOLANO Z ŁAPAMI ZACISK / GW

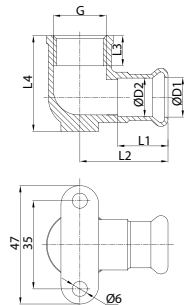

Indeks	Rozmiar	ØD1 mm	ØD2 mm	L1 mm	L2 mm	L3 mm	L4 mm	G
CA/ZM-471-15x1/2	15x1/2"	15,7	15,3	20	35	12	38	1/2"
CA/ZM-471-22x3/4	22X3/4"	22,7	22,3	21	45	13	44	3/4"